



Installation instructions

sonnenProtect 2500-AU-IN2-ATS

for sonnenBatterie eco 8.2

Table of Contents

1 Information about this document	4
1.1 Target group of this document	4
1.2 Designations in this document	4
1.3 Explanation of symbols	4
2 Safety	5
2.1 Intended use	5
2.2 Qualified electricians	5
2.3 Installation requirements of the sonnenProtect	6
2.4 Modifications or changes to the product environment.....	6
2.5 Operational voltage of the sonnenProtect	6
3 Product description.....	7
3.1 Technical data.....	7
3.2 System components.....	8
3.3 Function	8
4 Transport and storage.....	9
5 Mounting	9
5.1 Scope of Delivery	9
5.2 Selecting the installation location.....	10
5.2.1 Requirements for the location of the sonnenProtect 2500-AU-IN2-ATS.....	10
5.2.2 Requirements for the installation location of the sub / backup supply board	10
5.2.3 Observe minimum distances	10
6 Accessory installation	11
6.1 Removing the inverter cover	11
6.2 Installing the sonnenProtect 2500-AU-IN2-ATS accessory.....	12
6.3 Connecting the cable and strands	12
6.3.1 Removing the dummy plug.....	12
6.3.2 Installing the cable gland.....	13
6.3.3 Wiring the output cable.....	13
6.3.4 Connecting the cables and strands.....	14
6.4 Completing installation	15
6.4.1 Connecting to load circuits via backup sub-board.....	15
6.5 Monitoring the backup loads	15
7 Commissioning	16

7.1 Commissioning the storage system.....	16
7.1.1 Switching on the storage system.....	16
7.1.2 Switching on the grid voltage.....	16
7.2 Testing function	17
7.3 Setting up the sonnenProtect	17
7.3.1 Generating a commissioning code	17
8 Troubleshooting.....	18
9 Decommissioning.....	19
10.1.2 Disposal	19

1 Information about this document

This document describes the installation of the sonnenProtect 2500-AU-IN2-ATS accessory within the main unit of the sonnenBatterie eco 8.2 storage system containing a minimum of 6kW (x3 modules) of storage capacity.

- ▶ Read this document in its entirety before beginning the installation work.
- ▶ Keep this document in the vicinity of the sonnenBatterie.

1.1 Target group of this document

This document is intended for accredited sonnen installers & qualified electricians.

The actions described here must only be carried out by accredited sonnen installers & qualified electricians. The installation and commissioning of the sonnenBatterie and sonnenProtect 2500-AU-IN2-ATS must be carried out by an accredited sonnen installer.

1.2 Designations in this document

The following designations are used in this document:

complete designation	designation in this document
sonnenBatterie eco 8.2	storage system
sonnenProtect 2500-AU-IN2-ATS	sonnenProtect

1.3 Explanation of symbols

Extremely dangerous situation leading to certain death or serious injury if the safety information is not observed.



Dangerous situation leading to potential death or serious injury if the safety information is not observed.



Dangerous situation leading to potential injury if the safety information is not observed.



Indicates actions that may cause material damage. Important information not associated with any risks to people or property.



Symbol Meaning

- ▶ Work step
- 1. 2. 3. ... Work steps in a defined order
- List



2 Safety

2.1 Intended use

The sonnenProtect 2500-AU-IN2-ATS is an emergency power unit accessory designed to supplement the sonnenBatterie eco 8.2. The sonnenProtect provides power to be supplied to a connected sub-board and load circuits if a grid outage occurs.

Improper use poses a risk of death or injury to the user or third parties as well as damage to the product and other items of value.

The following points must therefore be observed to comply with the intended use of the product:

- Only install the sonnenProtect within the right storage system.
- The sonnenProtect must be installed by an accredited sonnen installer & qualified electrician.
- The sonnenProtect must only be connected within the storage system as described here. The output of the sonnenProtect must not be connected to the building mains.
- Only connect electrical loads that do not exceed the nominal power (in continuous operation) and maximum power (when switched on) of the sonnenProtect (2500W).



Failure to comply with the conditions of the warranty and the information specified in this document invalidates any warranty claims.

2.2 Qualified electricians

Improper installation can result in personal injury and/or damage to components. For this reason, the sonnenProtect must only be installed and commissioned by accredited sonnen installers & qualified electricians.

- Authorised electricians must meet the following criteria:
- The electrician must be a person with technical qualification, sufficient experience and current electrical license to enable him/her to avoid dangers which electricity may create.
- The electrician must also be a fully accredited sonnen installer certified by sonnen Australia.

2.3 Installation requirements of the sonnenProtect

Incorrect installation can lead to injury to yourself or others and cause damage to property.

- The sonnenProtect accessory must only be installed as described in the product documentation.

2.4 Modifications or changes to the product environment

- The sonnenProtect must only be installed in its original state without any user modifications and only when in perfect working order.
- Safety devices must never be overridden, blocked or tampered with.
- The interfaces of the sonnenProtect and the storage system must be wired in accordance with the product documentation.
- All repairs on the sonnenProtect must be performed by authorised service technicians only.

2.5 Operational voltage of the sonnenProtect

The sonnenProtect is connected to live electrical parts, which poses a risk of electrical shock. The storage system inverter also contains capacitors which carry voltage even after the storage system is switched off. As the sonnenProtect is directly connected to the inverter of the storage system, this means that the voltage from the inverter also flows into the sonnenProtect. Therefore:



- ▶ Disconnect the sonnenProtect from the power (see 9.2).
- ▶ Wait five minutes until the capacitors have discharged.

3 Product description

3.1 Technical data

System data

sonnenProtect 2500-AU-IN2-ATS

Maximum power	2,500 W
Nominal power	2,500 W
Output voltage (AC)	240 V +/- 10 %
Nominal frequency	50 Hz
Network configuration in emergency operation	IT
Operating concept	Single-phase – RCD protected wired supply
Switchover time approx.	0.2 seconds
Dimensions	
Dimensions (H/W/D) in mm	120/50/140
Weight in kg approx.	0.65 kg

Safety

Protection Standard	IEC 61009-1; AS/NZ 61009-1
Protective functions	Overcurrent & Earth Leakage
Degree of protection	IP 21 (as per sonnen eco 8.2 main unit)

Ambient conditions

Ambient temperature range	5 °C ... 40 °C
Storage temperature range	0 °C ... 50 °C
Transport temperature rang	-15 °C ... 50 °C
Maximum relative humidity	90 %, non-condensing
Permissible installation altitude	2,000 m above sea level
Additional ambient conditions	As prescribed for the storage system

3.2 System components

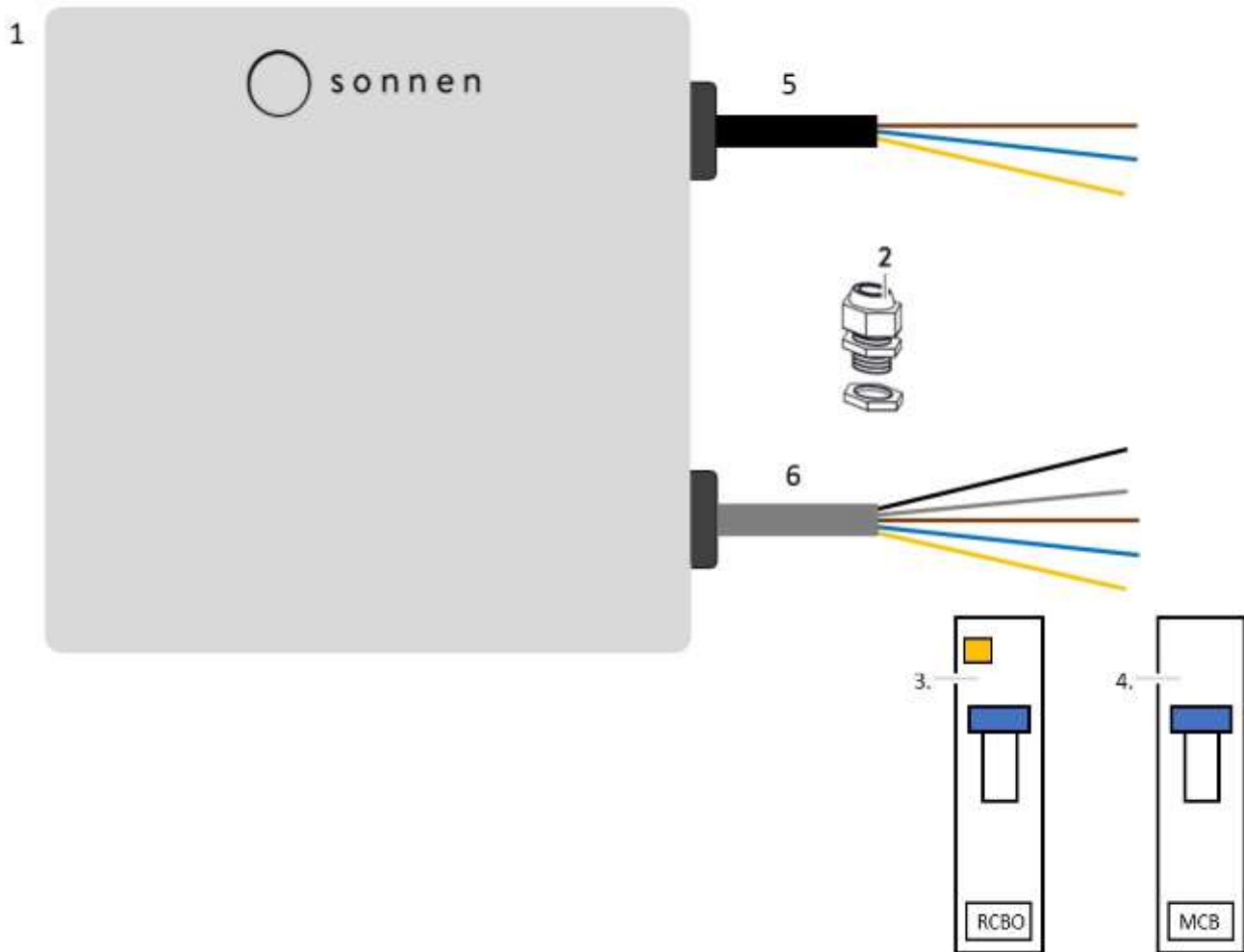

No.	Designation	Function
1	sonnenProtect2500-AU-IN2-ATS	Contactor module
2	Nylon Gland	Gland to allow for cable access into main unit
3	30mA RCBO	10A RCD for installer to connect to AC output
4	25A MCB	Main isolator for sonnenBatterie AC grid supply
5	VAC Output	Output supply to backup load circuits
6	VAC Input	Backup supply from Main Unit

3.3 Function

The outlet cable of the sonnenProtect supplies electrical power both in grid and emergency operation. The switchover time between grid and emergency operation is stated in the technical data. In the event that the sonnenBatterie is turned off or has an unexpected issue the power supply to the sonnenProtect backup circuits are automatically fed from the normal grid supply.

4 Transport and storage

Transport and storage conditions are defined in the product documentation of the storage system.

- Observe the same transport and storage conditions for the sonnenProtect.

5 Mounting

5.1 Scope of Delivery

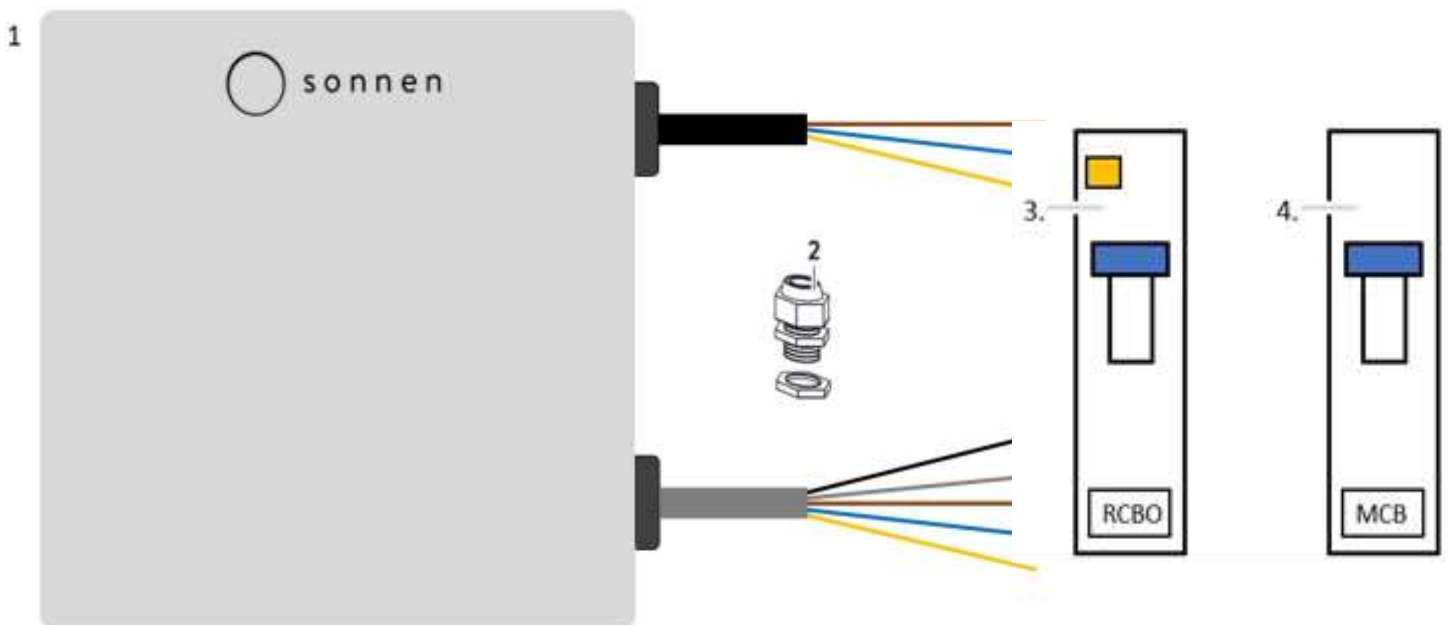

- Check the following scope of delivery to ensure it is complete.

No.	Designation
1	Pre-assembled sonnenProtect 2500-AU-IN2-ATS contactor assembly
2	M20 cable gland
3	30mA 10A RCD for installer to connect to AC output
4	25A MCB as main isolator for sonnenBatterie AC grid supply

5.2 Selecting the installation location

5.2.1 Requirements for the location of the sonnenProtect 2500-AU-IN2-ATS

- The sonnenProtect 2500-AU-IN2-ATS has been designed to allow for mounting either directly on the top of the sonnenBatterie main unit or wall mounted just above it.

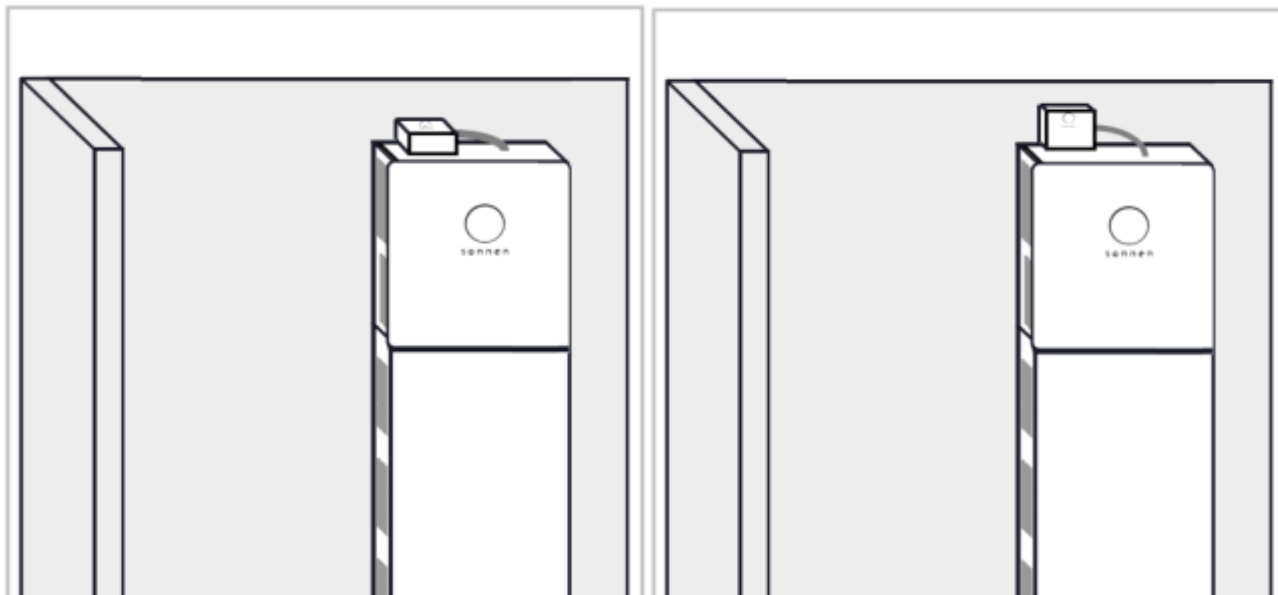

5.2.2 Requirements for the installation location of the sub / backup supply board

- ▶ Observe the required ambient conditions (see 3.1).
- The output cable of the sonnenProtect accessory is approximately 150cm allowing for the following optimal sub-board location to allow the unit to be easily reached.

5.2.3 Observe minimum distances

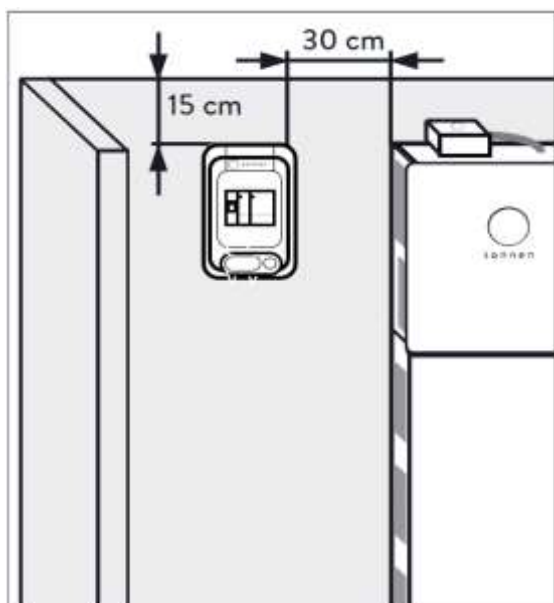

- ▶ Observe the minimum distances specified in Figure 6 between the device and the storage system and neighbouring objects.
- ▶ Install the sonnenProtect at the same level as the top edge of the storage system, if possible.

This keeps the cable lengths as short as possible.

The minimum distances ensure that;

- the sonnenProtect sub-board can be easily reached and
- sufficient space for installation and maintenance work.

6 Accessory installation



Electrical work on the storage system
Danger to life due to electrocution!

- ▶ Switch off the storage system.
- ▶ Disconnect the relevant electrical circuits.
- ▶ Remove the orange fuse connectors on all battery modules.
- ▶ Secure against anyone switching on the device again.
- ▶ Wait five minutes so the capacitors can discharge.
- ▶ Check that the device is disconnected from the power supply.
- ▶ Only authorized electricians & accredited sonnen installers are permitted to carry out electrical work.

6.1 Removing the inverter cover

Notice

Contact with the components inside the inverter
Damage to components due to electrostatic discharge (ESD)!

- ▶ Use ESD-compliant equipment.
- ▶ Do not touch any conductive components inside the inverter.

Tools:

- Allen screw | 5 mm
- Spanner | 10 mm
- ▶ Open the storage system.
- ▶ Remove the touch guard (2) and the cover (1) for the inverter.

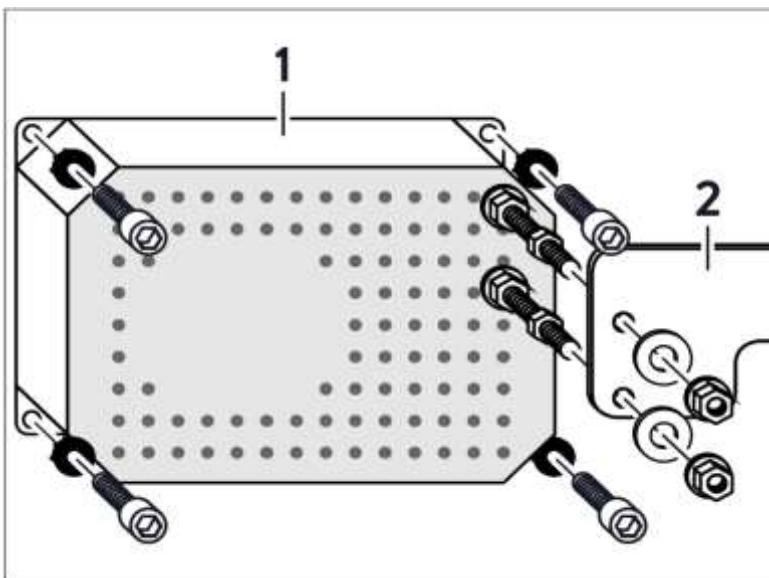

6.2 Installing the sonnenProtect 2500-AU-IN2-ATS accessory

► Install the sonnenProtect accessory either sitting flat on the top of the sonnenBatterie or mounted to the wall just above it.

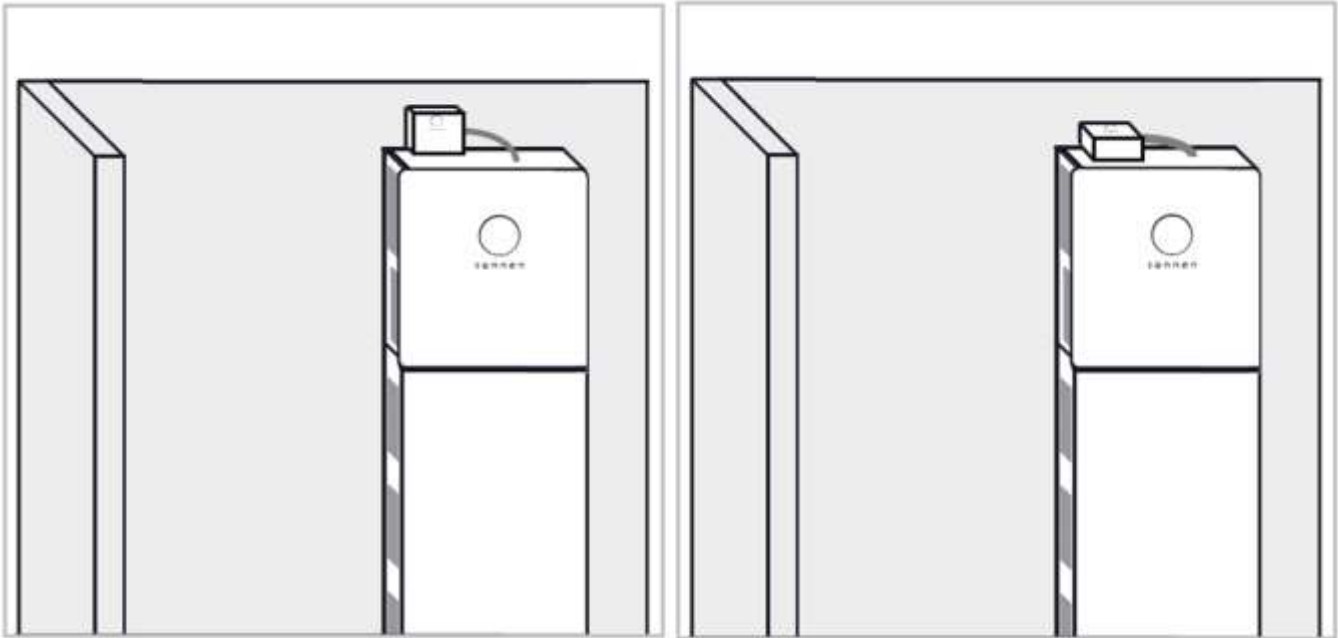

6.3 Connecting the cable and strands

6.3.1 Removing the dummy plug

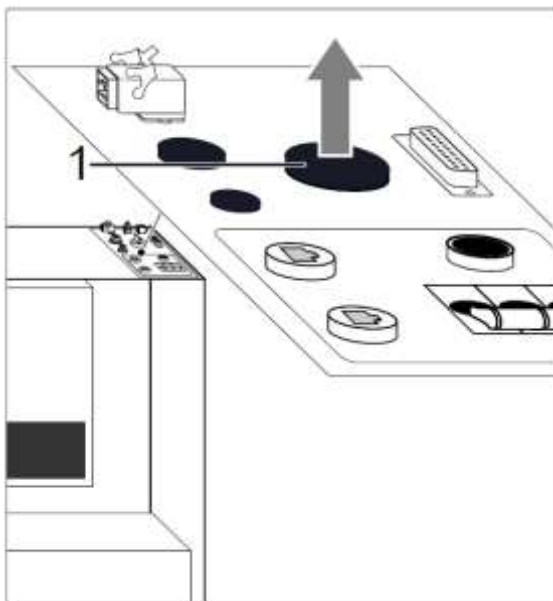

Tools:

- Screwdriver with a thin blade (0.4 mm)

Remove the dummy plug shown.

A screwdriver with a thin blade can be used for this purpose.

6.3.2 Installing the cable gland

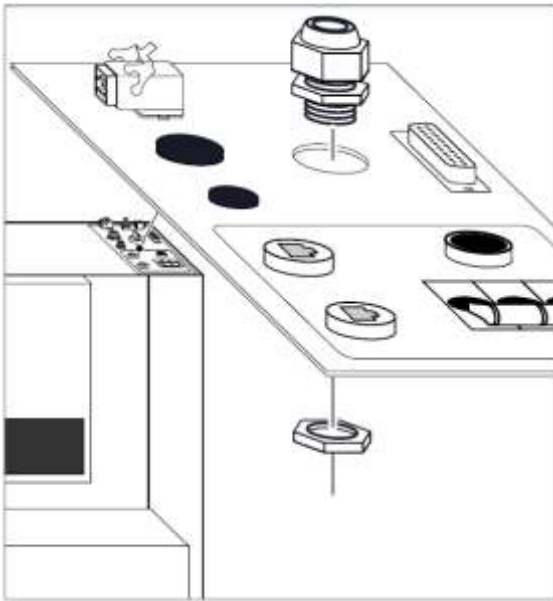

Tools:

- Spanner (25m)

Install the cable gland as shown.

6.3.3 Wiring the output cable

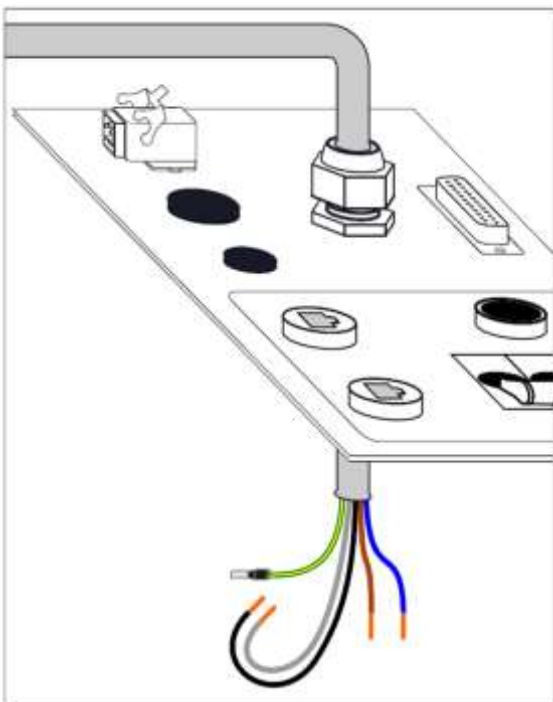

▶ Wire the connection cable of the sonnenProtect through the cable gland to the inside of the storage system.

▶ Only pass the output cable through the gland top the external of the main unit if the backup circuit is to be wired into a sub-board. If the accessory is not to be immediately connected, then leave the output cable & gland within the internal cavity of the main unit but do not connect the strands to the inverter.

▶ When wiring the output cable into a backup load switch board it is essential that the 30mA RCBO is used as the main switch and the supplied 25A MCB is used to protect the sonnenBatterie supply against any excess draw from the combination of battery charging and backup circuitry.

6.3.4 Connecting the cables and strands

Tools:

- Spanner | 10 mm | 5 Nm
- Stripping pliers
- ▶ Strip approx. 1 cm from the end of the black and grey cable.
- ▶ Connect the cable and pre-assembled strands as shown in Figure 13. Run the strands through the cable gland (3) to the inside of the inverter (1).
- ▶ Tighten the self-locking nut (5) with a torque of 5 Nm.

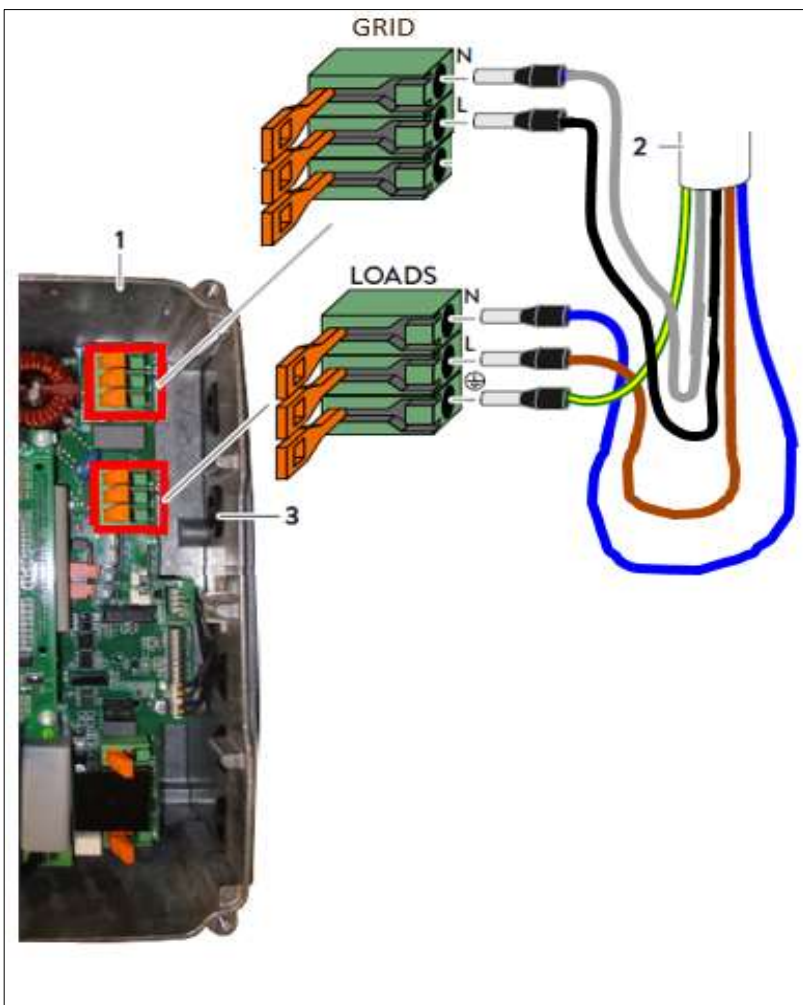

1. Inverter
2. Supply cable from sonnenProtect
3. Cable access

6.4 Completing installation

- ▶ Install the previously removed cover of the inverter and the touch guard.
- ▶ Close the storage system.

6.4.1 Connecting to load circuits via backup sub-board

The backup load circuits can be either wired directly from a dedicated backup sub-board supplied via the sonnenProtect accessory. Alternatively, the circuits can be fed from the existing switch panel which in turn is fed from the sonnenProtect accessory output cable in addition to the normal grid supply

The supply to the circuits powered from the sonnenProtect need to be protected by the 30mA RCBO which has been supplied with the sonnenProtect 2500-AU-IN2-ATS kit set.

If the loads are to be fed directly from the existing switch panel, then it is important to clearly label and identify those circuits being supplied as they will automatically be powered even when the grid has failed (when there is sufficient battery supply to enable the sonnenProtect).

It is essential that under normal load condition the appliances and/or load circuits being supplied by the sonnenProtect do not exceed 10A (2500W).

In some circumstances the combined power draw of both full charge rate of the sonnenBatterie (2500W) as well as the full power supply of the sonnenProtect (2500W) need to be considered. To enable this situation, included within the sonnenProtect 2500-AU-IN2-ATS kit set is a 25A main MCB which should be used as the sonnenBatterie MCB (Main AC isolator). In addition to the higher rating of the protective device the supply cable itself depending upon route length and location may also need to be replaced with a larger CSA cable.

The sub-board itself and any further protective devices for any sub-circuit will need to be supplied by the installer.

6.5 Monitoring the backup loads

The backup loads to be monitored in normal grid operation must become part of the load measured circuits by the sonnen system. To enable this the CT position and switchboard configuration must be installed in Setup 4 configuration.

7 Commissioning

7.1 Commissioning the storage system



It is essential to follow the instructions in the given order when switching on a storage system with sonnenProtect otherwise the storage system cannot function properly.

7.1.1 Switching on the storage system

Notice

If the storage system cannot be switched on:

▶ Do not attempt switching on the storage system more than three times.

▶ Contact sonnen service!

Further attempts can damage the battery modules.

Fuse switch F1 establishes the connection between the battery and the inverter. To be able to switch on fuse switch F1, switch S1 must also be pressed.

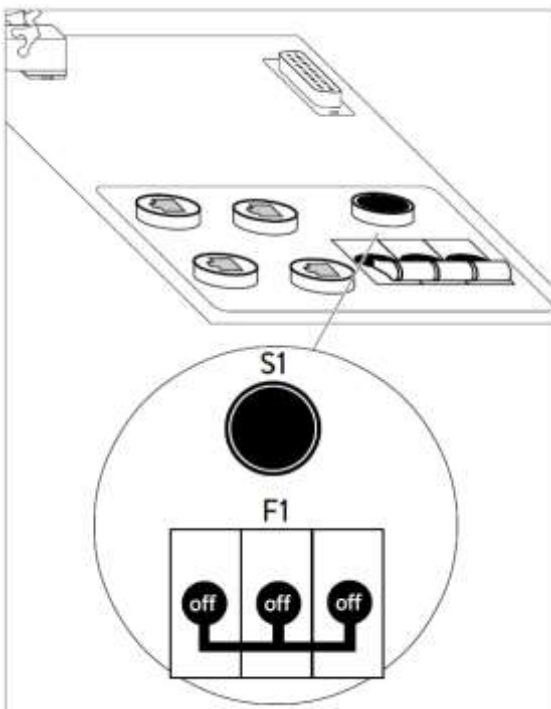

1 Press switch S1 and hold it down while the following steps are carried out.

2 Switch on fuse switch F1.

3 Keep switch S1 held down for at least another 5 seconds.

4 Release switch S1.

The storage system then starts up and performs a self-test. Once the self-test is successful, the storage system is ready to operate.

7.1.2 Switching on the grid voltage

▶ Switch on the grid voltage using the AC miniature circuit breaker.

7.2 Testing function

Before the sonnenProtect is operated, a function test must be carried out:

1. Wait until the storage system is completely started up.
2. Check whether the sonnenProtect is behaving as described for grid operation in section 3.3.
3. Switch off the AC miniature circuit breaker at the mains line to the storage system to simulate a grid outage.
4. Check whether the sonnenProtect is behaving as described for emergency operation in section 3.3.
5. Press the test key of the RCD to simulate an insulation fault of the sub-board.
6. Check whether the sonnenProtect is behaving as described for emergency operation in section 3.3.
7. Ensure that the illuminated eclipse of the sonnen main unit has turned green whilst the unit is in backup mode.

If the sonnenProtect is behaving as described in section 3.3, the function test is successful. The sonnenProtect can be operated. If the sonnenProtect is not behaving as described in section 3.3, the sonnenProtect must not be operated.

- ▶ In this case, check the wiring (see section 6.3.4).
- ▶ Contact sonnen support if the problem cannot be resolved.

7.3 Setting up the sonnenProtect

7.3.1 Generating a commissioning code



We recommend that you generate a commissioning code before installing the sonnenProtect on the premises of the sonnenBatterie operator

Conditions:

- ✓ There must be an Internet connection
- ✓ You must have access details for the Internet portal
- ▶ Enter the following address into your browser's address line to access the Internet portal:
<https://my.sonnen-batterie.com>
- ▶ Log on to the Internet portal.
- ▶ Go to the page called 'sonnenProtect'.
- ▶ Enter the serial numbers of the sonnenBatterie and the sonnenProtect units which are to be connected.
You will find the serial numbers on each unit's type plate.
- ▶ Confirm your entries. The commissioning code will be displayed.
- ▶ Make a note of the commissioning code.

8 Troubleshooting

Disturbance	Possible reason	Correction
The output of the sonnenProtect is not supplying any power. The RCD has switched off.	There is an insulation fault.	▶ Correct the insulation fault.
The output of the sonnenProtect is not supplying any power. The RCD has switched on.	There is a grid outage. The battery is completely discharged.	▶ Wait until the public grid begins supplying power again.
	The miniature circuit breaker of the sub-circuits is switched off. The storage system is switched off.	▶ Switch on the miniature circuit breaker. ▶ Switch on the storage system.
The RCD and/or overall power from the sonnenBatterie is switching off immediately, or after the sonnenProtect has been operating for a longer period.	An electrical consumer with a power consumption rating that is too high is connected to the output of the sonnenProtect.	▶ Only connect loads with a power consumption that does not exceed the nominal power of the sonnenBatterie. ▶ Only connect loads with a power consumption that does not exceed the maximum power of the sonnenProtect when switched on.
The page 'sonnenProtect' is not available within the commissioning assistant.	The storage system has a non-current software version installed.	▶ Make sure that the storage system is connected to the internet. ▶ Go to the first page of the commissioning assistant and start an update by clicking on the button 'Install System Updates'.

9 Decommissioning



Voltage in the event of a grid outage
Danger to life due to electrocution!

The output of the sonnenProtect remains live even in the event of a grid outage or when the main fuses are switched off.

- ▶ The sonnenProtect must be switched off separately.

9.1 Switching off the output

- ▶ **Switch off the RCD (RCBO).**
The power output of the sonnenProtect is switched off.

9.2 Disconnecting the sonnenProtect from the power supply

Before working inside the sonnenProtect, it must be completely disconnected from the power supply:

1. Switch off the RCD (RCBO).
2. Disconnect the storage system from the power supply.
3. Wait at least five minutes until the capacitors inside the storage system inverter have discharged.
4. Check that the voltage is no longer active.

10 Uninstallation and disposal

10.1 Uninstallation



Improper uninstallation of the sonnenProtect
Danger to life due to electrocution!

- ▶ The sonnenProtect must only be uninstalled by authorized electricians.

10.1.2 Disposal



The sonnenProtect must not be disposed of as domestic waste!

- ▶ Dispose of the sonnenProtect in an environmentally friendly way through the relevant recycling facility.

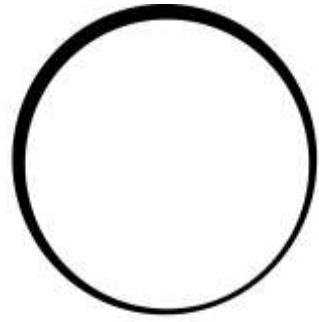

sonnen

www.sonnen.com.au
www.sonnensupport.com.au