

Single Phase Meter Board option 1

The following meter board illustration shows the correct placement of the CT's if sitting all of the components is possible within a single enclosure.

The three-phase setup would be identical albeit allowing for the additional phases;

**Sonnen – Domestic Installation – Consumption Measurement
 Main Board – Option 1**

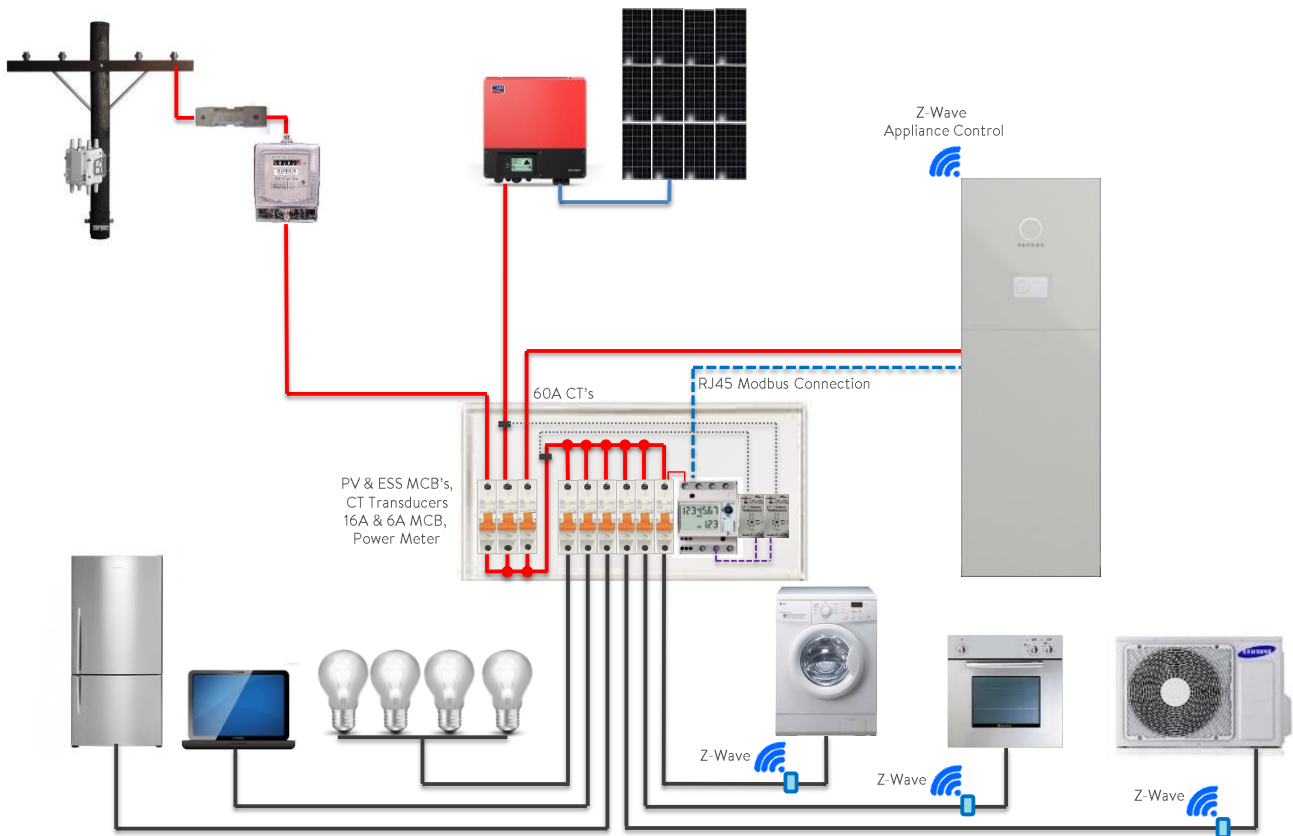

30.10.2020

sonnen Australia Pty Ltd

3

Single Phase Meter Board option 2

The following meter board illustration shows the correct placement of the CT's if sitting all of the components is not possible within a single enclosure and a sub-board is required, please note that in this scenario all of the metering and transducer arrangement is within the sub-board also.

The three-phase setup would be identical albeit allowing for the additional phases;

Sonnen – Domestic Installation – Consumption Measurement Sub Board – Option 2

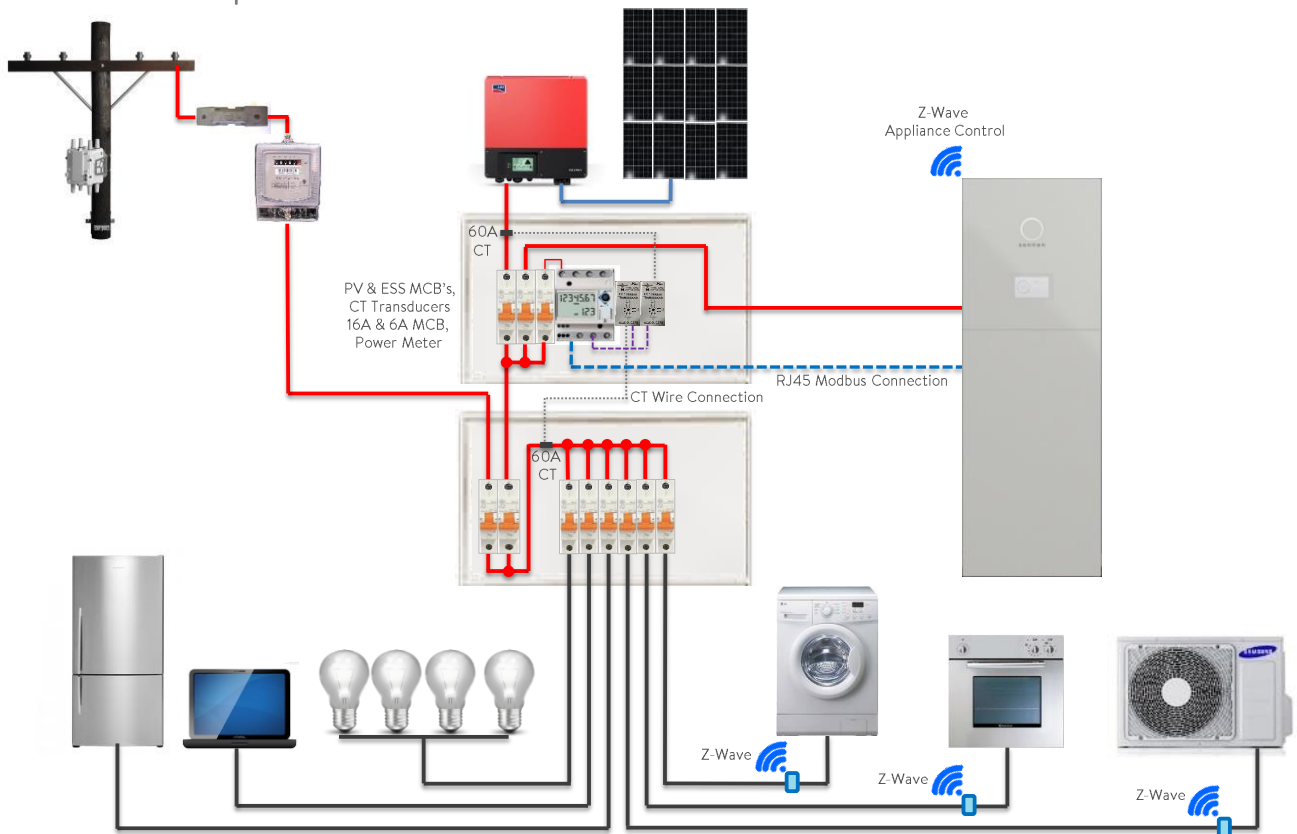

30.10.2020

sonnen Australia Pty Ltd

6

Single Phase Meter Board option 3

The following meter board illustration shows the correct placement of the CT's if sitting all of the components is not possible within a single enclosure and a sub-board is required. In some circumstances, the sub-board may be a distance from the main switch board so the consumption CT connection will need to be extended, in this circumstance it is possible to extent the black RJ12 connector between the transducer and the meter A2 input.

Please note that in this scenario the metering and solar PV transducer arrangement is within the sub-board but the transducer and consumption transducer and CT's are within the main switch board.

The three-phase setup would be identical albeit allowing for the additional phases;

Sonnen – Domestic Installation – Consumption Measurement Sub Board – Option 3

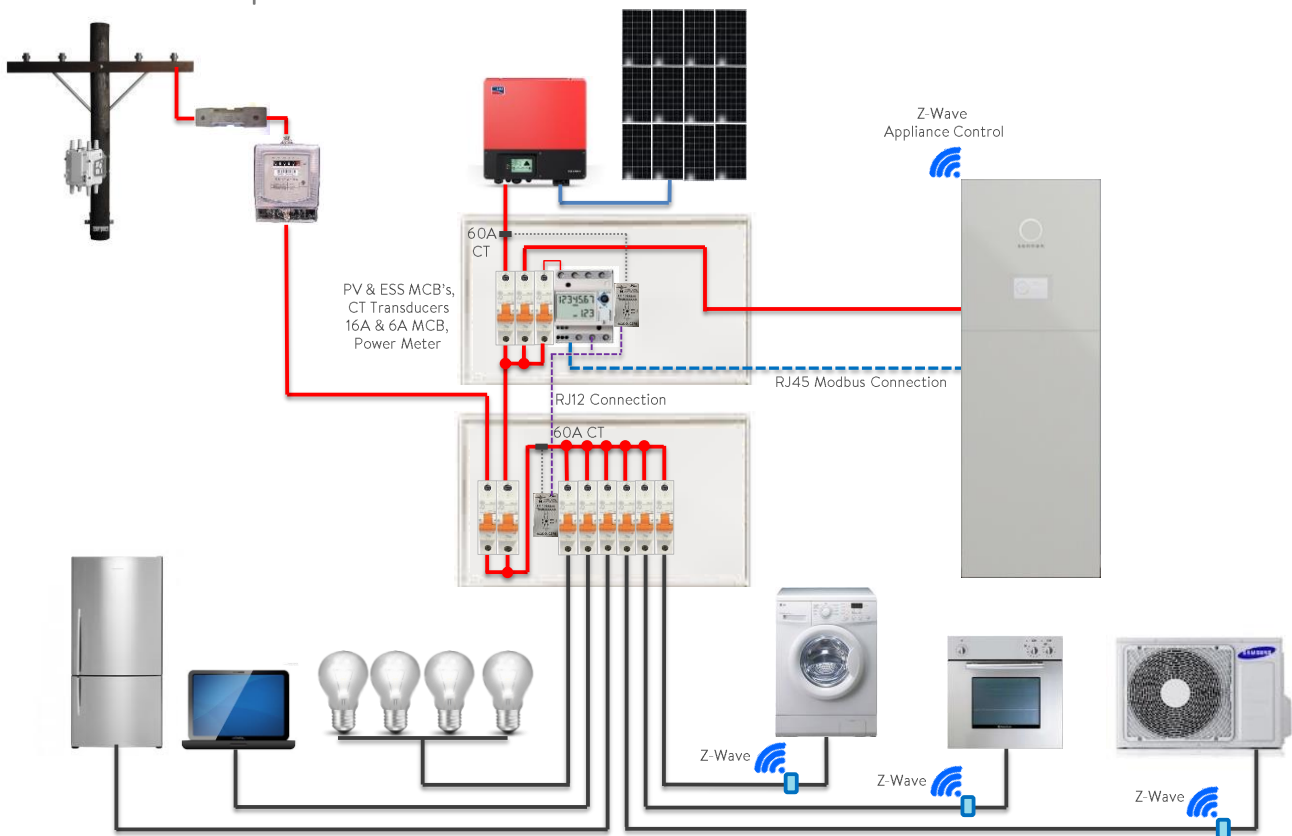

30.10.2020

sonnen Australia Pty Ltd

8

Single Phase Meter Board option 4

The following meter board illustration shows the correct placement of the CT's if sitting all of the components is not possible within a single enclosure and an intermediary sub-board is required in between the main incoming supply and the switch board panel.

The three-phase setup would be identical albeit allowing for the additional phases;

**Sonnen – Domestic Installation – Consumption Measurement
 Sub Board – Option 4**

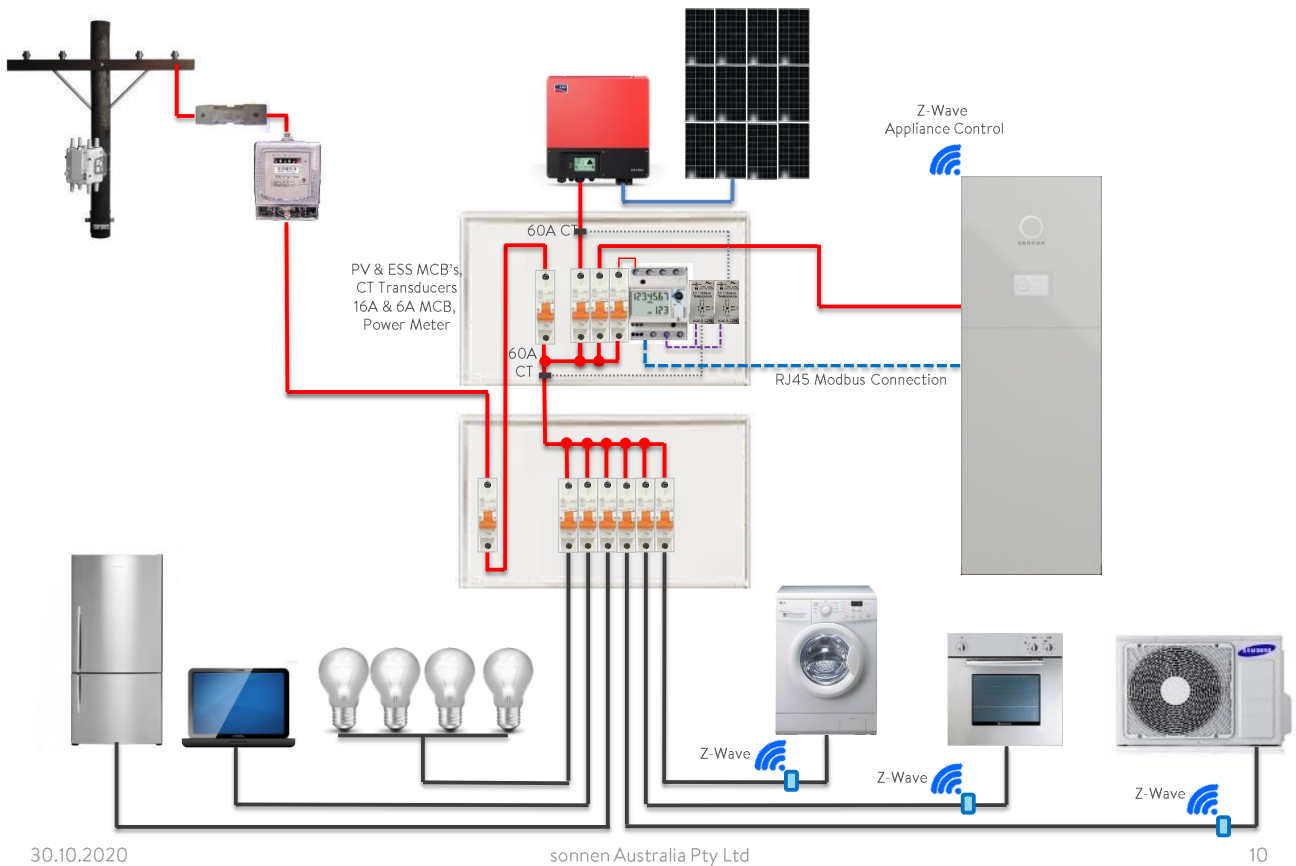

Single Phase Meter Board option 4.5

The following meter board illustration shows the correct placement of the CT's if sitting all of the components is not possible within a single enclosure and an intermediary sub-board is required in between the main incoming supply and the switch board panel.

The three-phase setup would be identical albeit allowing for the additional phases;

Sonnen – Domestic Installation – Consumption Measurement
 Sub Board – Option 4.5

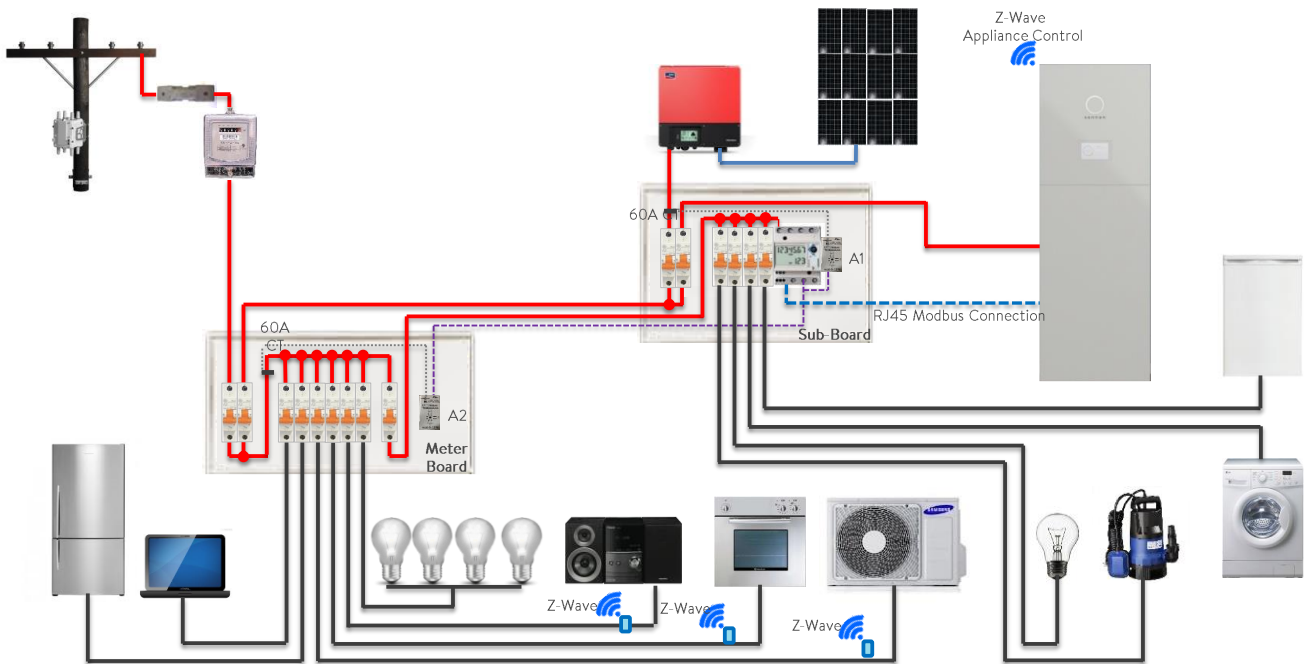

Single Phase Meter Board option 5

The following meter board illustration shows the correct placement of the CT's if two sonnen systems are stacked.

From an operational perspective both sonnen systems will see the full PV production, if the load exceeds the PV production then sonnen system 2 discharges (system closest to the loads). Sonnen 1 will see the load as being load minus the sonnen systems 2 discharge or a lesser actual load volume. If, however, there is more load than sonnen system 2 can meet then in addition sonnen system 1 will also discharge as well to meet the load.

If the PV exceeds the load then sonnen system 2 starts to charge, at this point sonnen system 1 will see the household load including sonnen 2 charging or a greater load scenario. If there is still excess PV production the sonnen system 1 will charge also, any excess over and above this then gets exported to the grid.

The following illustration assumes it is possible to house all of the components within a single enclosure, if however, this is not possible then please refer to the previous meter board setup options.

The three-phase setup would be identical albeit allowing for the additional phases;

Sonnen – Domestic Installation – Consumption Measurement Sub Board – Option 5

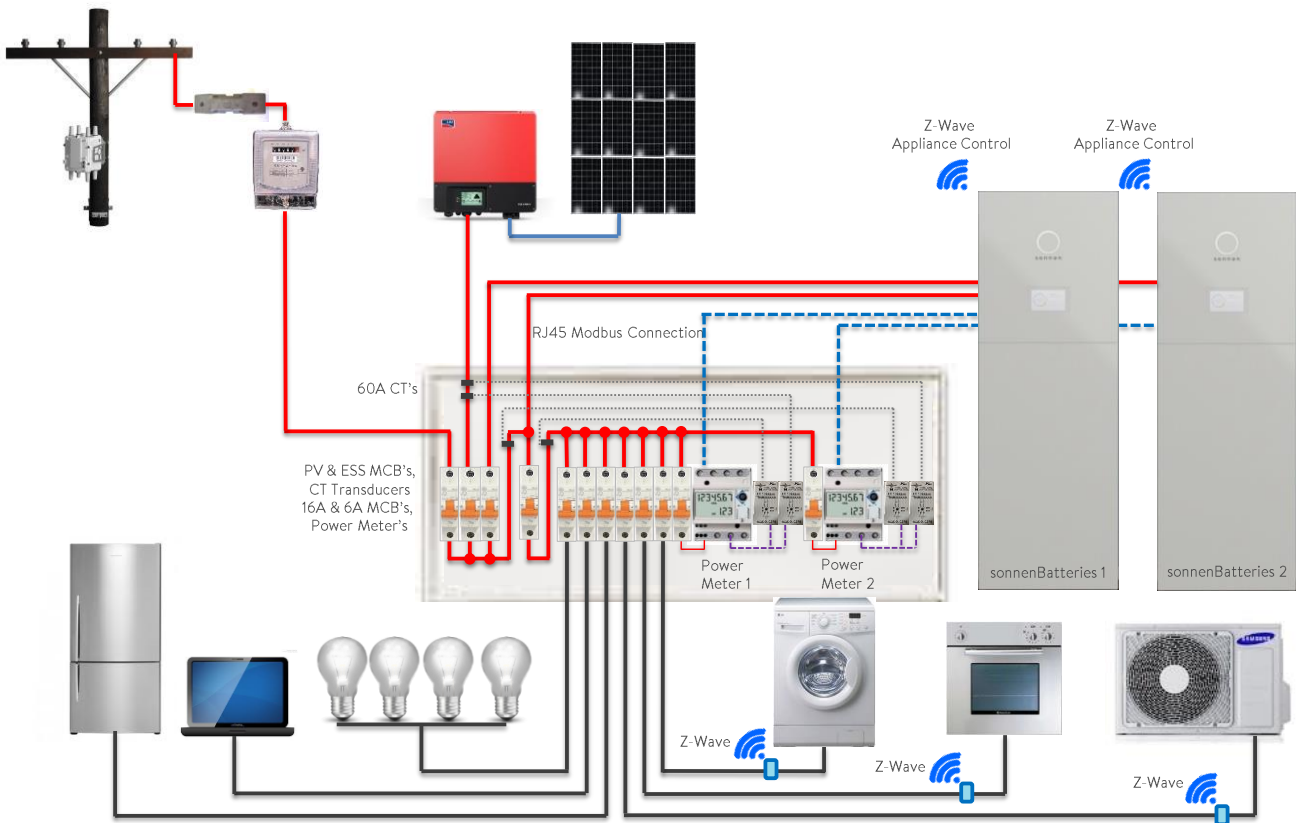

Please note that on the single phase sonnen systems it is not possible to cut off the unused CT's.

Although it is a requirement to only use one of the three CT's supplied on each of the production and consumption feeds, the sonnen system has been calibrated to account for the resistance of all CT's, so cutting them off leads to erroneous data.

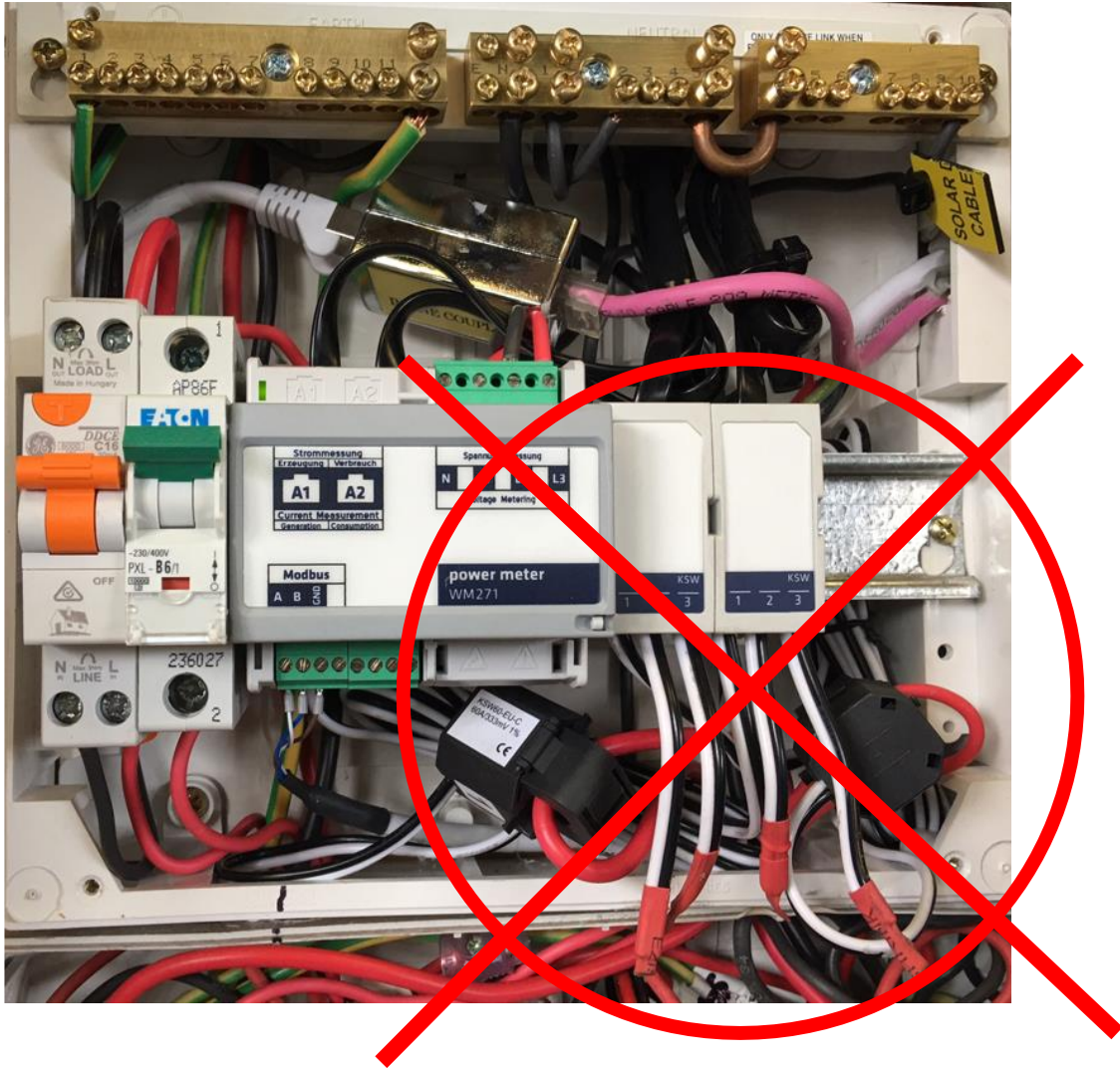

If you have any further questions or require support or assistance, please contact us at support@sonnen.com.au.

Yours faithfully,

Aylmer Ambu
Technical Sales Engineer Australia & New Zealand